

Product Fact Sheet

Collect Lighting Collection



ferm
L I V I N G



Collect Lighting – Bell Pendant

The Bell Pendant is carefully constructed from durable powder-coated steel and boasts a minimalist aesthetic. As part of the Collect Lighting Series, it is available in various complementary colours that can be seamlessly paired with other pieces in the series. This pendant offers numerous pairing options, allowing you to combine it with decorative bulbs or any lampshade from the same series to achieve ideal illumination for your space. The socket pendant comes complete with a decorative brass ring, canopy ceiling mount and 3 metre fabric-covered electrical cord.



1104269681
Light Grey



1104269679
Cashmere



1104269683
Brass



1104269680
Black



1104269682
White

Information

Size: Ø: 9 x H: 10.4 cm / Ø: 3.5 x H: 4.1 in
Material: Powder coated or brass plated iron with a 3 metre cord and canopy in a matching colour.
Brass/chrome ring included
Care: Wipe with a damp cloth
Voltage: 220-240V - 50Hz
Light source: E27 max 25 watt incandescent / 13 watt LED. Bulb not included
Certifications: CE, CB, UKCA, RoHs.
 Only approved for EU/NO/CH/UK
Classification: IP20, Class II
Country of origin: China
Net weight: 0.7 kg / 1.5 lb
Packsizes: 2

Measurements

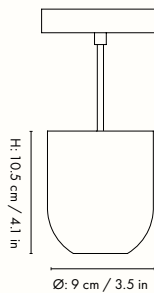

Collect Lighting – Socket Pendant Low

This sleek barrel fixture forms the core of the COLLECT Lighting series. This short pendant can be used alone with a decorative bulb to create ambient lighting or together with any one of the lampshades in the series to illuminate your chosen room to suit your style and mood. The socket pendant comes complete with a decorative brass ring, canopy ceiling mount and 3m fabric-covered electrical cord.



1104269677
White



5110
Light Grey



100295693
Cashmere



5106
Brass



5108
Black

Information

Size: Ø: 6 x H: 10.2 cm / Ø: 2.4 x H: 4 in
Material: Powder coated iron. All with a 3 metre fabric cord and canopy in the same colour
Care: Wipe with a damp cloth
Voltage: 220-240V - 50Hz
Light source: E27 max 25 watt incandescent / 13 watt LED. Bulb not included
Info: Separate version for US. Registered design
Certifications: Only approved for EU/NO/CH/UK
Classification: IP20, Class II
Country of origin: China
Net weight: 0.6 kg
Packsize: 2



Measurements

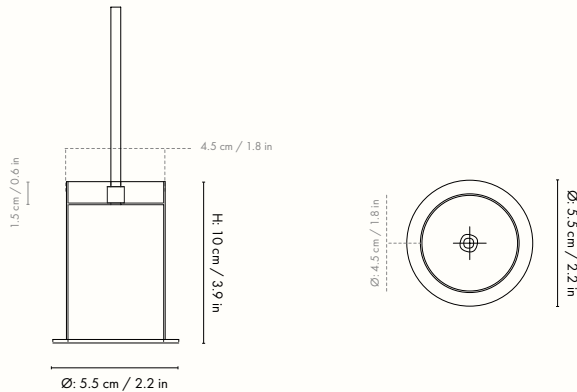

Collect Lighting – Socket Pendant High

This sleek barrel fixture forms the core of the COLLECT Lighting series. This long pendant can be used alone with a decorative bulb to create ambient lighting or together with any one of the lampshades in the series to illuminate your chosen room to suit your style and mood. The socket pendant comes complete with a decorative brass ring, canopy ceiling mount and 3m fabric-covered electrical cord.



1104269675
White



5111
Light Grey



100297693
Cashmere



5107
Brass



5109
Black

Information

Size: Ø: 6 x H: 17 cm / Ø: 2.4 x H: 6.7 in
Material: Powder coated iron. All with a 3 metre fabric cord and canopy in the same colour
Care: Wipe with a damp cloth
Voltage: 220-240V - 50Hz
Light source: E27 max 25 watt incandescent / 13 watt LED. Bulb not included
Info: Separate version for US. Registered design
Certifications: Only approved for EU/NO/CH/UK
Classification: IP20, Class II
Country of origin: China
Net weight: 0.6 kg
Packsize: 2



Measurements

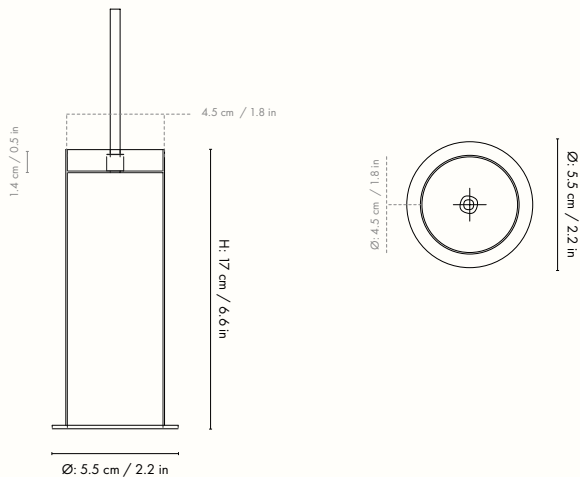

Collect Lighting – Bell Opal Shade

The Bell Opal Shade is crafted from opaque glass, a material favoured in 16th-century Venice that has been revived to create a cherished piece of contemporary home decoration today. As part of the Collect Lighting Series, it can be seamlessly paired with other pieces in the series. Its elegant design showcases graceful curves and a bell-shaped silhouette, perfect for hanging above a dining table or kitchen island to produce a cosy and welcoming ambience.



1104269691
White

Information

Size: Ø: 16.9 x H: 18 cm / Ø: 6.7 x H: 7.1 in

Material: Opal glass with glossy finish

Care: Wipe with a damp cloth

Country of origin: China

Net weight: 0.5 kg / 1.1 lb

Packsize: 2

Measurements

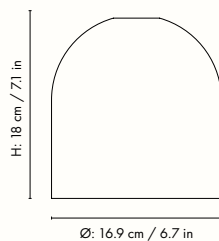

Collect Lighting – Bell Shade

The Bell Shade is carefully constructed from brass-plated metal and boasts a minimalist design aesthetic. As part of the Collect Lighting Series, it is available in various complementary colours that can be seamlessly paired with other pieces in the series. Its elegant design showcases graceful curves and a bell-shaped silhouette, perfect for hanging above a dining table or kitchen island to produce a cosy and welcoming ambience.



1104269687
Light Grey



1104269684
Cashmere



1104269689
Brass



1104269686
Black



1104269688
White

Information

Size: Ø: 16.9 x H: 18 cm / Ø: 6.7 x H: 7.1 in
Material: Powder coated or brass plated iron.
White inside lampshade
Care: Wipe with a damp cloth
Country of origin: China
Net weight: 0.5 kg / 1.1 lb
Packsize: 2

Measurements

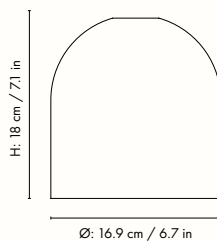

Casca and Opal Shades – Sphere

The origin of opaque glass is found in the wonders of 16th century Venice but has today been revived as a cherished piece of contemporary home decoration. The translucent white glass of the lampshades spread the light evenly in a room and provide a soft lighting in all rooms of your home. The opal shades are available in two shapes: Sphere and tall. Match them with the sockets of our Collect Lighting series and you have a perfect ceiling light for your living room, pendant over your kitchen counter or a classic lamp for the bedroom.



1104264809
Casca – Milk



5148
Opal – White



1101722835
Opal – Southern Moss

Information

Size: Ø: 25 x H: 23.6 cm / Ø: 9.8 x H: 9.3 in
Material: Casca: Glass with solid coloured dots.
 Opal: Opal glass with glossy finish
Care: Wipe with a dry cloth
Info: Mouth-blown glass
Country of origin: China
Net weight: 0.9 kg
Packsize: 1

Measurements

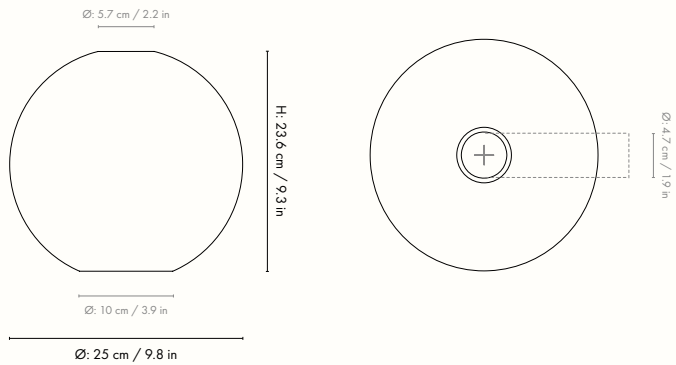

Opal Shades – Tall

First made in 16th century Venice, opal glass continues to add beauty to homes on modern lamps and lights. Our timeless Opal Shade is crafted from the legendary glass, spreading light evenly in a room and adding a sophisticated touch to interiors. Available in two shapes – sphere and tall – the shade fits out Collect Lighting sockets to create ceiling lamps in a living room, task pendants above a kitchen counter, or ambient lights in a bedroom.



1104264810
Casca – Milk



5149
Opal – White

Information

Size: Ø: 18.6 x H: 34.2 cm / Ø: 7.3 x H: 13.5 in
Material: Casca: Glass with solid coloured dots.
 Opal: Opal glass with glossy finish
Care: Wipe with a dry cloth
Info: Mouth-blown glass
Country of origin: China
Net weight: 1.2 kg
Packsize: 1

Measurements

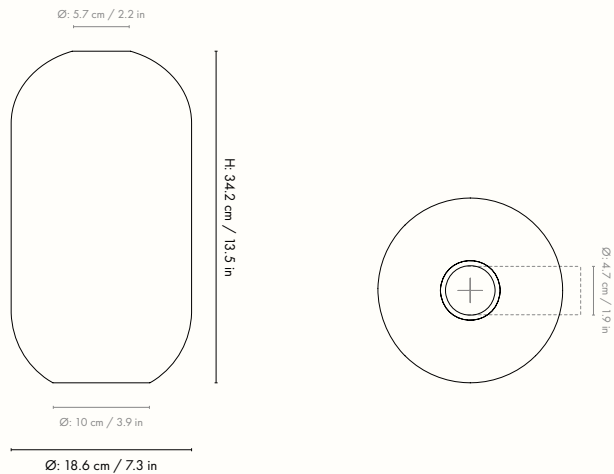

Collect – Cone Shade

Inspired by classic Coolie and Empire-style lampshades, this powder coated metal design has a conical shape and light-reflecting white interior that disperses the light directly where you need it. A future classic, this lampshade is compatible with all socket pendants from the Collect Lighting series.



5118
Light Grey



100299693
Cashmere



110410501
Brass



5133
Black



1104269669
White

Information

Size: Ø: 25 x H: 12 cm / Ø: 9.8 x H: 4.7 in
Material: Powder coated iron.
 White inside lampshade
Care: Wipe with a damp cloth
Info: Registered design
Country of origin: China
Net weight: 0.4 kg
Packsize: 2 / US: 1

Measurements

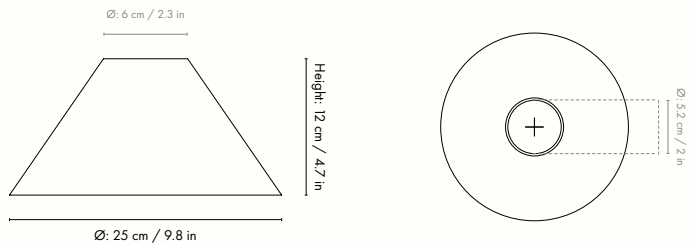

Collect – Hoop Shade

Elegant and understated, this curvilinear lampshade in powder coated metal provides subtle accent lighting to illuminate your bedside, kitchen surfaces or chosen corner of a room. The interior is coated white to ensure optimal light reflection, and the lampshade is compatible with all socket pendants in the Collect Lighting series.



100300102
Light Grey



100300693
Cashmere



110409501
Brass



5121
Black



1104269670
White

Information

Size: Ø: 20 x H: 7 cm / Ø: 7.9 x H: 2.8 in
Material: Powder coated iron.
 White inside lampshade
Care: Wipe with a damp cloth
Info: Registered design
Country of origin: China
Net weight: 0.3 kg
Packsize: 2 / US: 1

Measurements

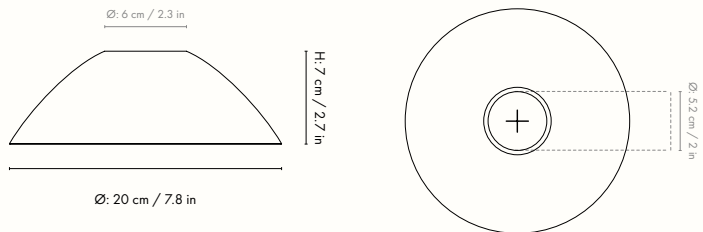

Collect – Disc Shade

Providing subtle downward lighting for food preparation, reading or simply for ambience, this small lampshade directs light to where you need it. The design lends a warm accent to any room, complementing almost every interior style. Create a retro-inspired look and pair with any socket pendant from the Collect Lighting series.



5127
Light Grey



100301693
Cashmere



5126
Brass



5146
Black



1104269671
White

Information

Size: Ø: 12 x H: 7 cm / Ø: 4.7 x H: 2.8 in
Material: Powder coated iron.
 White inside lampshade
Care: Wipe with a damp cloth
Info: Registered design
Country of origin: China
Net weight: 0.2 kg
Packsize: 2 / US: 1

Measurements

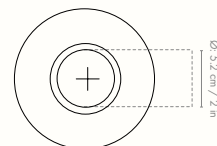
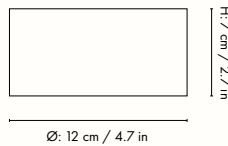

Collect – Angle Shade

This grand, open lampshade provides a large and bright source of light, which will make a powerful statement hanging over any dinner table. Made of powder coated metal, it forms a sculptural element in a room, yet with its clear lines seamlessly blends into your home. This lampshade fits with any of the socket pendants of the Collect Lighting series.



100074693
Cashmere



100074101
Black



1104269672
White

Information

Size: Ø: 58 x H: 10.5 cm / Ø: 22.8 x H: 4.1 in
Material: Powder coated iron.
 White inside lampshade
Care: Wipe with a damp cloth
Info: Registered design
Country of origin: China
Net weight: 1.5 kg
Packsize: 1

Measurements

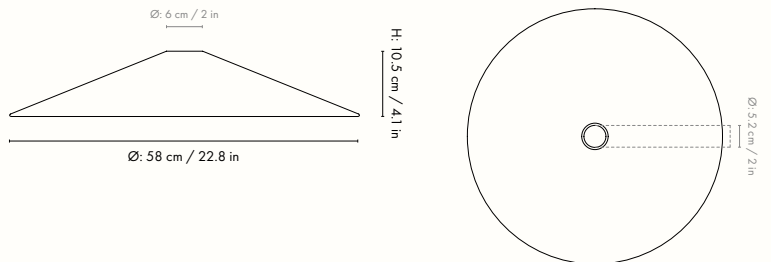

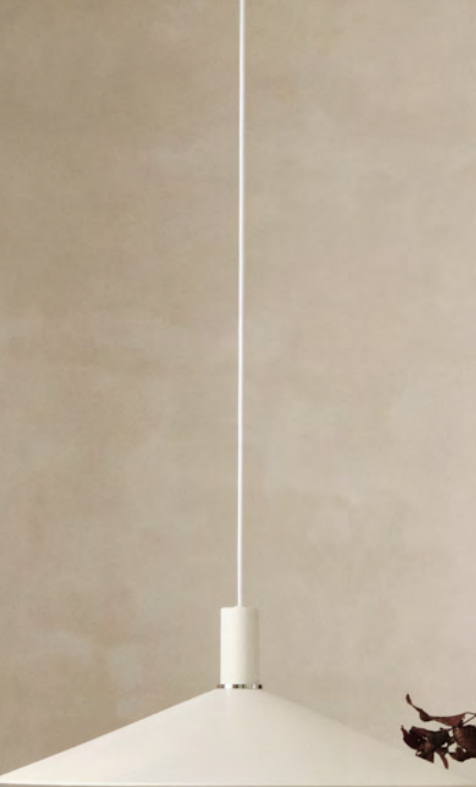

Collect – Dome Shade

This classically domeshaped lampshade is designed to be a primary light source for dining or reading. Directing and focusing the light where you want it, this large and decorative shade is crafted in powder coated metal with a light-reflecting white interior. The lampshade is compatible with all socket pendants from the Collect Lighting series.



5123
Light Grey



100303693
Cashmere



5142
Brass



5138
Black



1104269673
White

Information

Size: Ø: 38 x H: 16 cm / Ø: 11 x H: 6.3 in
Material: Powder coated iron.
 White inside lampshade
Care: Wipe with a damp cloth
Info: Registered design
Country of origin: China
Net weight: 1 kg
Packsize: 2 / US: 1

Measurements

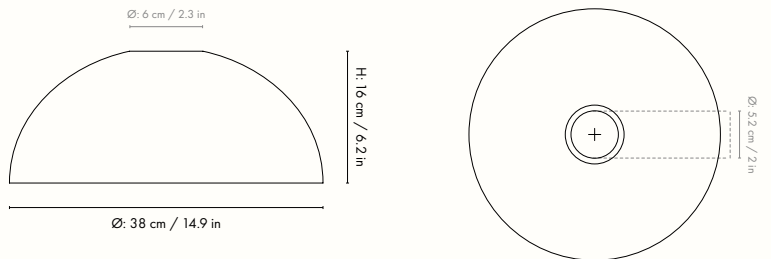

Collect – Record Shade

With a nod to retro forms, this shallow drum-shaped pendant radiates strong light downwards thanks to its reflective white interior. Providing a decorative element to your interior design, this powder coated metal lampshade is part of the interchangeable Collect Lighting series.



100302102
Light Grey



100302693
Cashmere

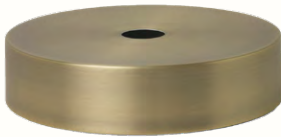

5145
Brass



5124
Black



1104269674
White

Information

Size: Ø: 30 x H: 7 cm / Ø: 11.8 x H: 2.8 in
Material: Powder coated iron.
 White inside lampshade
Care: Wipe with a damp cloth
Info: Registered design
Country of origin: China
Net weight: 1 kg
Packsize: 2 / US: 1

Measurements

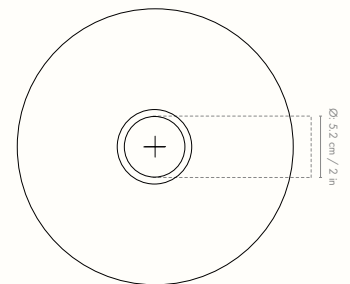
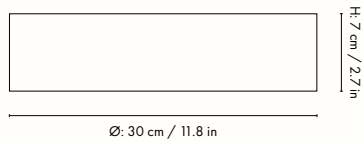

Collect – Ring

Bring imagination to your room and create perfectly balanced contemporary lighting with our COLLECT Lighting Series, offered in multiple shapes and colours. Adding this decorative metal ring to your favourite lampshade and chosen socket pendant, completes the design of your personal lightning.



100608503
Chrome



100608502
Black Brass

Information

Size: Ø: 5.5 x H: 0.5 cm / Ø: 2.2 x H: 0.2 in

Material: Chrome plated iron or black brass plated iron

Care: Wipe with a dry cloth

Info: Add-on to Collect Lighting

Country of origin: Taiwan

Net weight: 0.1 kg

Packsize: 1

Easy to Collect

Canopy

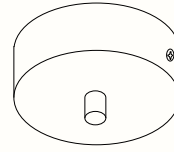
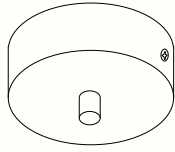

Brass ring



Shade

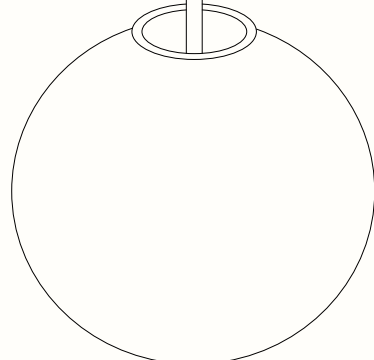
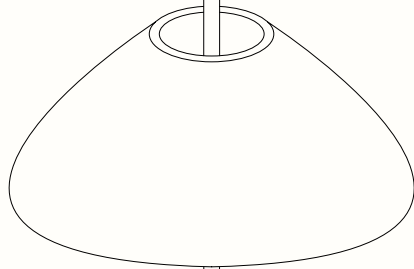

Socket pendant

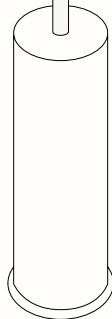

Bulb

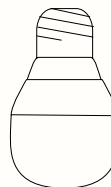

Space to feel comfortably you