



CARE INSTRUCTIONS

Daily cleaning can be done by wiping the frame with a clean dry cloth. Should the surface need more attention this can be cleaned with water and a light detergent or soap applied with a damp cloth. Wipe after with a clean dry cloth. Avoid any abrasive materials.

TROUBLESHOOTING

If lamp does not light, turn off the power. Check the bulb for a broken filament. Replace bulb if necessary, then turn it on. If the lamp still does not light, please contact customer service at the local dealer. If the external flexible cable or cord of this lamp is damaged, it must be replaced by a qualified electrician in order to avoid a hazard.

TECHNICAL INFORMATION

Recommended light source:
4x E14, 350-400 Lumen, ~4-5W LED, dimmable

Turn power off when changing light bulb. Isolation class II.
The lamp is not approved for outdoor use or use in damp/wet rooms (IP20)



For enquiries contact GUBI A/S - CVR: 17940384
Klubiensvej 7-9, 2150 Nordhavn, Copenhagen, Denmark

T +45 69 15 60 60 – order@gubi.com

GUBI.COM

138-20-001-01 Assembly Instructions Howard Chandelier 4 Armed, Short EU

GUBI

ASSEMBLY INSTRUCTIONS

for

Howard Chandelier 4-Arm Short

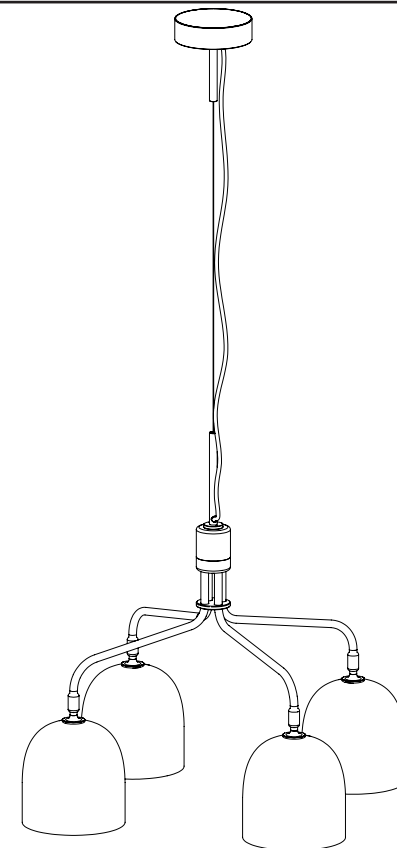

CONTENTS

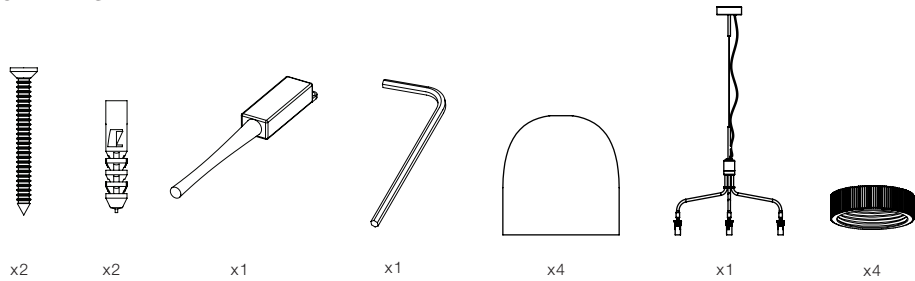

1.

Mount the ceiling bracket with the two supplied wood screws.

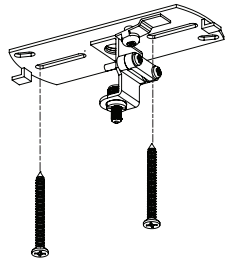

2.

Insert the hanging wire and electrical cable through the canopy.

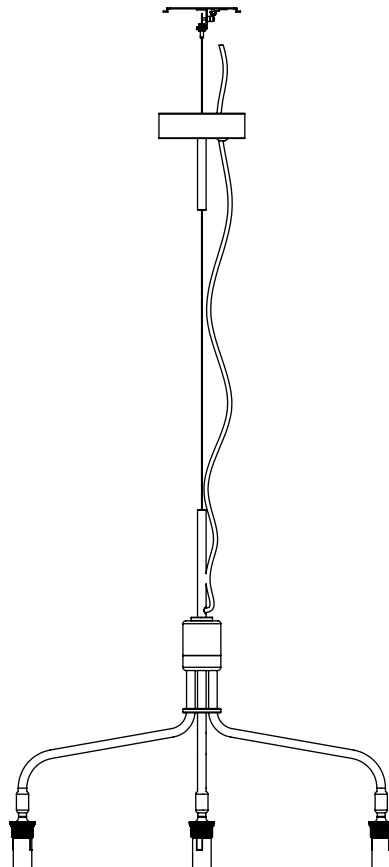

3.

Loosen the suspension terminal sleeve (a) and adjust the height of the lamp by pulling the wire through the suspension terminal (b). Secure the wire by tightening the set screw on the metal ball (c) and re-attach the sleeve. Coil or cutting the surplus wire. Adjust the length of the electrical cord, leaving ample slack.

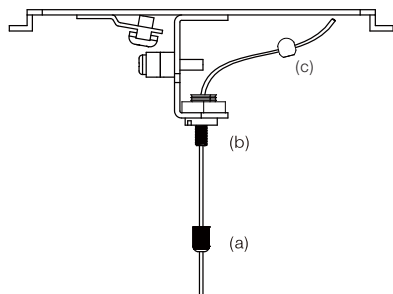

4.

Connect lamp L and N wires to mains wires in the supplied screw terminal and place it inside the canopy.

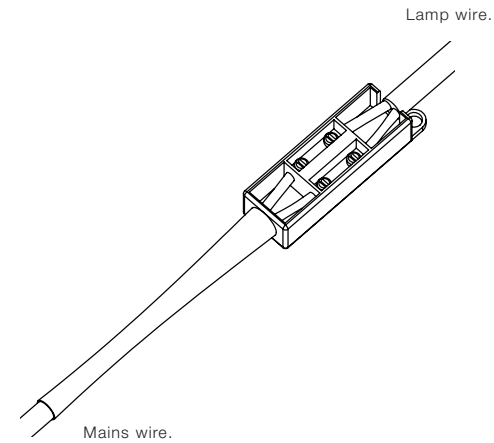

5.

Secure the lamp wire in the strain relief and attach the canopy to the ceiling bracket by rotating it by approximately 5-20 degrees.

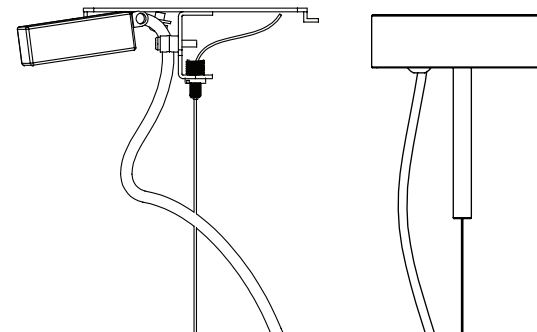

6.

Assemble the shades onto the base by using the supplied mounting rings

